

## ÖLABLASSSCHRAUBEN / DICHRINGE FÜR PKWS | OIL DRAIN PLUGS & GASKETS FOR CARS

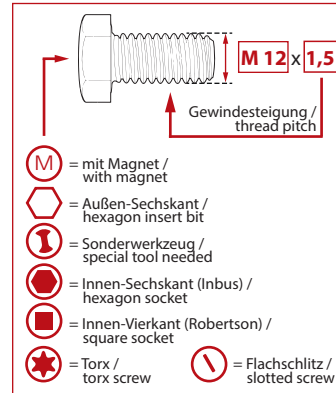

### Schraube / screw



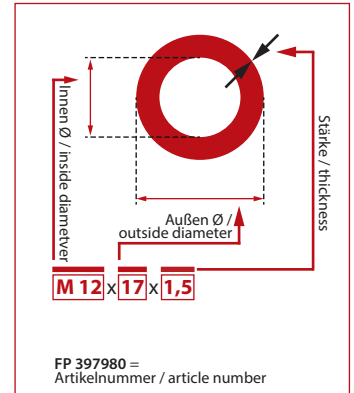

### Dichtring / gasket







### Material / material



- AL-a1 = Aluminium, nach DIN 7603 Form A
- CU-a1 = Kupfer, nach DIN 7603 Form A
- CU-F-c = Kupfer, nach DIN 7603 Form C
- FeSn-F-c = Stahl verzinkt, nach DIN 7603 Form C
- NF 231-a1 = Novaform231 (Weichstoff)
- PA6 = Werkstoff PA6 (Kunststoff)
- VF-a1 = Vulkanfaser, nach DIN 7603 Form A

	
FP 855560 OAS-097 M 10 x 1,25	FP 119120 CU-a1 10,2 x 20,5 x 2
Citroën, Ford, Mini, Peugeot, Suzuki, Toyota, Volvo	



	
FP 768920 OAS-083 M 12 x 1,5	FP 397980 CU-a1 12 x 17 x 1,5
BMW	

	
FP 539770 OAS-004 M 12 x 1,75	Dichtring ist Bestandteil der Schraube / Part of the screw
Opel 652454, Fiat 71739255, GM 11519408 / 11562588, Ford 1535683 / 4948795, Land Rover LR0250448, Mazda CY10404, Opel 652736 / 652884 / 652951 / Volvo 31359503	



	
FP 647490 OAS-009 M 12 x 1,75	Dichtring ist Bestandteil der Schraube / Part of the screw
Ford 7 123 346, 3 051 079, F53E-6730-CA	



	
FP 308480 OAS-084 M 14 x 1,25	FP 253550 CU-F-c 14 x 21 x 2
Citroën, Fiat, Ford, Lancia, Peugeot, Opel, Suzuki, Toyota, Volvo	



	
FP 1004635 OAS-055 M 14 x 1,5 Kit: 822360	FP 602990 O-Ring NBR 70 18 x 2
Alfa Romeo-Fiat-Lancia, BMW, GM, Citroën, Ford, Opel, Suzuki, Vauxhall	



	
FP 1000898 OAS-057 M 14 x 1,5	FP 259150 CU-a1 14 x 20 x 1,5
Opel, Vauxhall	

	
FP 967230 OAS-011 M 14 x 1,5	FP 259150 CU-a1 14 x 20 x 1,5
Opel 652 475 / 652 491, GM 90409376 / 9275631, Saab 45 02 142	

	
FP 256850 OAS-096 M 14 x 1,5	Dichtring ist Bestandteil der Schraube / Part of the screw
Chrysler, Citroën, Ford, Peugeot, Volvo	

	
FP 518470 OAS-086 M 14 x 1,5	FP 259150 CU-a1 14 x 20 x 1,5
Audi, Ford, Seat, VW	

	
FP 427410 OAS-081 M 14 x 1,5	FP 885860 PA6 14,5 x 22 x 2
Ford	

	
FP 588670 OAS-006 M 14 x 1,5	Dichtring ist Bestandteil der Schraube / Part of the screw
Audi, Ford 1459212 / 6M216B709AA, Seat, Skoda, VW N 908 132 02, Porsche N91101401, Mitsubishi MN980254	

## ÖLABLASSSCHRAUBEN / DICHRINGE FÜR PKWS | OIL DRAIN PLUGS & GASKETS FOR CARS



### Schraube / screw

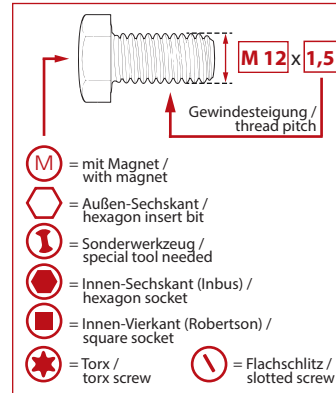

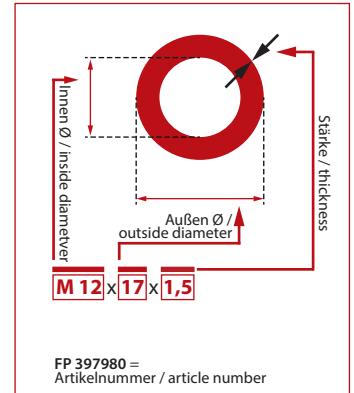

### Dichtring / gasket





### Material / material



- AL-a1 = Aluminium, nach DIN 7603 Form A
- CU-a1 = Kupfer, nach DIN 7603 Form A
- CU-F-c = Kupfer, nach DIN 7603 Form C
- FeSn-F-c = Stahl verzinkt, nach DIN 7603 Form C
- NF 231-a1 = Novaform231 (Weichstoff)
- PA6 = Werkstoff PA6 (Kunststoff)
- VF-a1 = Vulkanfaser, nach DIN 7603 Form A



	
FP 1012441 OAS-105-VW M 14 x 1,5	Dichtring ist Bestandteil der Schraube / Part of the screw
Volkswagen 06L 103 801 (Spezialwerkzeug nötig)	



	
FP 770420 OAS-018 M 14 x 1,5	FP 259150 CU-a1 14 x 20 x 1,5
Verschlusschraube gem. DIN 910	

	
FP 564470 OAS-056 M14 x 1,5 x 24	FP 259150 CU-a1 14 x 20 x 1,5
Chrysler 05073945AA, MB 601 997 02 03	

	
FP 606190 OAS-087 M 16 x 1,5	FP 948330 CU-F-c 16 x 20 x 2
Chrysler, Citroën, Nissan, Opel, Peugeot, Renault, Vauxhall, Volvo	



	
FP 1000980 OAS-101 M 18 x 1,5	FP 87210 NF 231-a1 18 x 28 x 2
Toyota	

	
FP 935930 OAS-090 M 18 x 1,5	FP 301980 CU-F-c 18 x 24 x 2
Ford, Renault	

	
FP 1007815 OAS-047 M 18,1 x 1,5 x 21	FP 1002190 Typ3 FPM 80 18,7 x 26 x 1,5
Opel 652 300, Fiat 55196505 / 55188007, GM 93183669 / 55588255	

	
FP 1000899 OAS-054 M 18 x 1,5	FP 284150 AL-a1 18 x 24 x 2
Alfa Romeo 60812431 / 60813578, Fiat, Lancia, Suzuki	

	
FP 95410 OAS-091 M 20 x 1,5	FP 740620 VF-a1 20,4 x 27 x 3
Ford, Peugeot, Volvo	

	
FP 48710 OAS-021 M 20 x 1,5	FP 598870 CU-a1 20 x 26 x 1,5
Subaru	

	
FP 1008250 OAS-044 M 21 x 1,75	FP 495710 AL-F-c 22 x 29 x 2
Volkswagen 2RD103193	N0138293

	
FP 445410 OAS-080 M 22 x 1,5	FP 649590 CU-F-c 22 x 27 x 2
Alfa, Chrysler, Citroën, Fiat, Ford, Opel, Peugeot, Renault, Vauxhall	

## ÖLABLASSSCHRAUBEN / DICHRINGE FÜR PKWS | OIL DRAIN PLUGS & GASKETS FOR CARS



### Schraube / screw

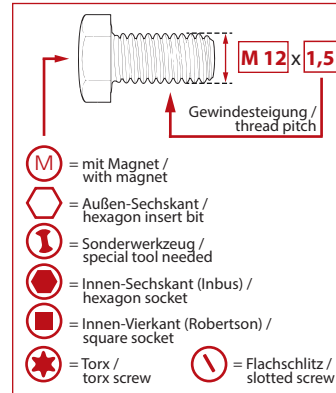

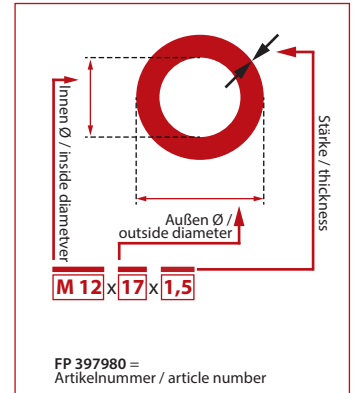

### Dichtring / gasket







### Material / material

AL-a1	= Aluminium, nach DIN 7603 Form A	NF 231-a1	= Novaform231 (Weichstoff)
CU-a1	= Kupfer, nach DIN 7603 Form A	PA6	= Werkstoff PA6 (Kunststoff)
CU-F-c	= Kupfer, nach DIN 7603 Form C	VF-a1	= Vulkanfaser, nach DIN 7603 Form A
FeSn-F-c	= Stahl verzinkt, nach DIN 7603 Form C		

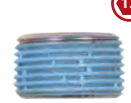

	
FP 142020 OAS-093 M 22 x 1,5	FP 67810 AL-a1 22 x 27 x 1,5
BMW	



	
FP 195320 OAS-022 M 22 x 1,5	FP 846760 CU-a1 22 x 27 x 1,5
Verschlusschraube gem. DIN 910	



	
FP 866360 OAS-059 M 22 x 1,50	Dichtring ist Bestandteil der Schraube / Part of the screw
Citroën, Fiat, Peugeot	



	
FP 1008251 OAS-043 M 24 x 1,5	FP 1000571 FeSn-F-c 24 x 32 x 2,5
Audi, VW	

	
FP 1008252 OAS-042 M 26 x 1,5	FP 737520 CU-a1 26 x 32 x 1,5
MB 130 997 00 32, 136 997 12 30, 346 997 00 30	007603026301
Audi, VW	



	
FP 280750 OAS-094 M 26 x 1,5	FP 528870 CU-a1 26 x 31 x 2
Audi, VW	

	
FP 1015053 OAS-109 Ø 28 x 38 mm	Dichtring ist Bestandteil der Schraube / Part of the screw
MB A 002 990 20 17	

	
FP 485210 OAS-012 M 12 x 1,75	Dichtring ist Bestandteil der Schraube / Part of the screw
Fiat 71739255, GM 11519408/11562588, Ford 1535683/4948795, LR 025048, Mazda CY1-10-404, Opel 652454/652884/652951/ 652736, Volvo 31359503	

	
FP 186320 OAS-013 M 12 x 1,5	FP 397980 CU-a1 12 x 17 x 1,5
BMW 07119903199, MB 0029973430/ 1239970130/1239970430, Chrysler 0029973430, 05073890AA	

	
FP 1000944 OAS-015 M 18 x 1,5	FP 905330 CU-a1 18 x 24 x 1,5
Volvo 986833/978138/9186135/982547, Ford 1422665/W7118145443, Land Rover LR000499	

	
FP 1014394 OAS-048 M 14 x 1,5	Dichtring ist Bestandteil der Schraube / Part of the screw
BMW 11137513050, VW 7B0103624, Chrysler 0654018/06504894AA/06506100AA/ 06506214AA, Fiat 50047057	